



Innovations in Fluid Sealing.
www.inmarco.ae

Sealing Valves Correctly
will boost Plant Performance



Valve Sealing

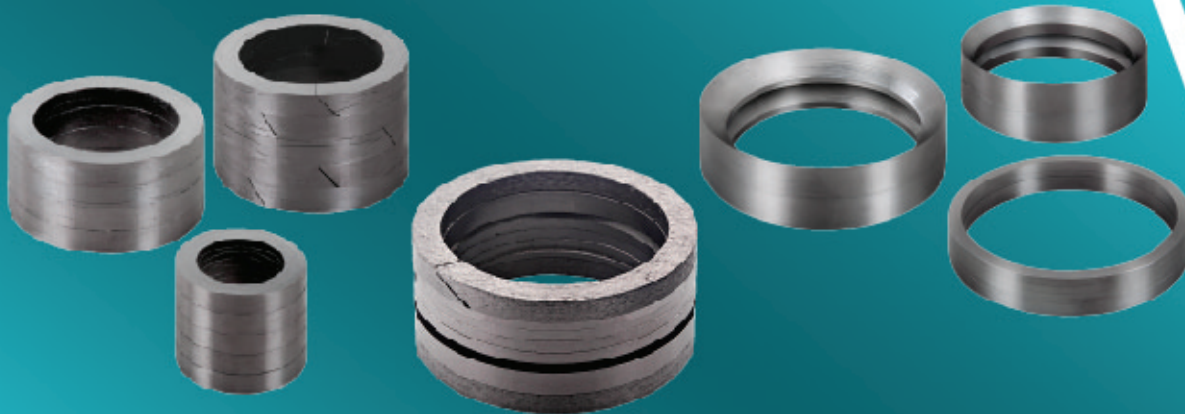



ABOUT US

INMARCO is one of the leading manufacturer of superior quality "Fluid Sealing Products" accepted and approved by variety of industries. Inmarco has attained market leadership in fluid sealing industry through its dedication to customer service and product development. Inmarco is committed for continuous improvement and has grown throughout three decades contributing to the environmental friendly Sealing Solutions. Non Asbestos culture has been driven and many a personnel to understand the asbestos menace in today's life. Inmarco's clientele are happy and satisfied of our untiring support for the sealing problems. Based on technological capabilities and perfection achieved over the years, Inmarco provides a wide range of products and services to the maintenance Industry. Our determinations to conduct business on a global scale is supported by and reflected in a fundamental philosophy utilization of technological expertise/ accumulation over three decades to access changes that occurred with passage of time while continuously evolving previously unexplored areas.

VALUES

With MARKET-oriented structures, new and stronger product offerings, technically skilled-employees and efficient environmental impact MANAGEMENT SYSTEM, armed with global rapport with similar manufacturing companies and access to the latest development in the industry and a resilient local spirit, we are dedicated to delivering the best results. It is our people who make the system come alive and turn these principles, policies, and procedures into reality.

MISSION & VISION

MISSION - Values - a driving force for Change...

A company rooted in unweaving values, INMARCO keeps ahead of change, reaping opportunities for growth. Striving to maintain leadership in industrial sealing products with wide manufacturing range. Providing a high quality product that combines performance with value for pricing, while establishing a successful relationship with the customers.

VISION - To be a market leader surpassing all hurdles of the industry, automate the process, systematized supplies and offer twenty-four-seven on service.

WARE HOUSING

Located in the heart of the world business hub at SAIF Zone Sharjah UAE. Equipped with State of European Machinery.

STOCKS - The Warehouse stocks varieties of exotic raw materials for ever demanding modernized applications.

STORES - The temperature control stores takes care of the wellbeing and enhances shelf life of raw materials and the finished products.

INSPECTION - We never choose cheap materials, every incoming shipment follows stringent inspections system and are stored at predefined locations.

PACKING AND DISPATCH - Latest packing methodology in use with the modern gadgets and simplified equipments to perform efficient packing.

TECHNOLOGIES & RESOURCES

INMARCO is driven by using non asbestos materials and is committed to provide superior and quality products that passed international standards and are environmental friendly. Technologies has helped develop more advance processes and has produced unwanted by-products causing pollution and deplete natural resources to the detriment of the earth and its environment that causes threat not only in the environment but also to mankind. With its philosophy in non-asbestos fluid sealing products INMARCO is able to do its part in conserving the environment.

CREDENTIALS



Inmarco is pleased to offer 24/7 onsite technical and installation services. Inmarco is specialized in manufacture of valve sealing systems and is proud to announce that the recently developed expandable version of valve cart seal has outperformed the expected results. Certified by American Petroleum institute under standard ANSI/API standard 607 Fifth Edition – and API 589 Second Edition . We offer valve seal refurbishment and can undertake onsite jobs also.

- Construction
- Chemical Processing
- Food & Beverage
- Marine & Dry-docking
- Oil & Gas
- Pharmaceuticals
- Power Generation Desalination & Waster Water
- Paper & Pulp
- Steel & Aluminum

CERTIFICATIONS & APPROVALS



Cartseal Fire Safe Certified As Per Api 607



Packing Style 100fxi-special Conform To Fugitive Emission Norms As Per Api 622



Packing Style 100fxi-special Fire Safe Certified Asper Api 607



Borogue

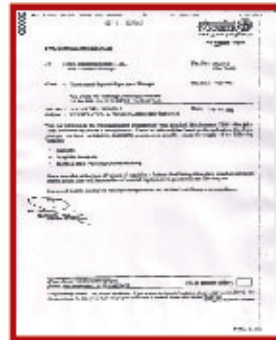

Takreer



Gasco



Ruwais Fertilizer Industries (Fertil)



Adgas



Adco



Petroleum Development Of Oman



Qatar Petroleum

INMARCO GUIDELINES FOR STUFFING BOX DIMENSIONS

Rotating Shafts: Dimension A shown on this drawing is the total depth of packing including lantern gland. A standard depth of $7W$ or 7 times the packing space has been established when a lantern gland is used. A depth dimension is used where lantern gland is omitted. (Refer Fig.1).

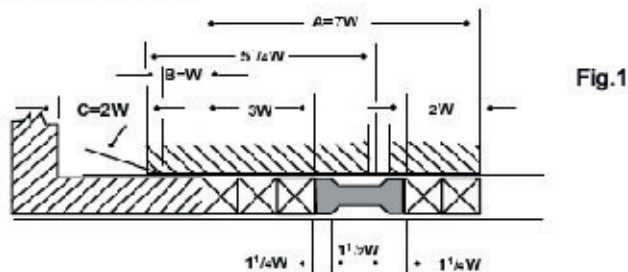

Fig.1

Lantern Gland Position: It should be noted that the illustration shows the dimension of $2W$ on the pressure side of the lantern ring and $3W$ on the gland end of the stuffing box. While this is a common practice, it should be noted that $3W$ on the pressure side and $2W$ on the gland end of the stuffing box can also be used. For proper set up consult INMARCO sales personnel.

Gland take-up: This gland take-up is limited to 40% of the packing. The reason for this limitation is to include those packings which will have the largest volume loss. Additional gland take-up is not recommended, in order to prevent galling of the shafts. This means that complete take-up will take place before equipment is damaged; therefore, packing replacement would be indicated. This is based on the theory that most damage is done during the late running of packing life.

Lantern Ring: (Also known as Seal cage) – The suggested depth or length of lantern ring is set at $2W$.

Chamfer Depth: A minimum of $1/8''$ (3mm) is recommended. It is felt that less than $1/8''$ (3mm) will not contribute to easy entry of packing.

Chamfer Angle: Wedging or guiding action is between 15 and 30 degrees.

Gland Entrance: It is recommended that a minimum of $1W$ be maintained to minimize the probability of gland cocking and allow for general variations of soft packing, molded and other types.

Size Limitation: In designing equipment with shaft below $5/8''$ (16mm) diameter, consult INMARCO regarding packing space required (W).

Clearance: Clearances should be as per acceptable machining practices, taking into consideration thermal expansion and contraction of metals.

Finishes: Finishes of rotating elements in contact with packing should be best economically possible, bearing in mind that the finer or smoother the finish, the longer the packing life expectancy.

Pressure: These standard dimensions are intended for the use up to approximately 1500psi (102bar).

Performance: Performance at various high speeds is a function of the material used rather than the stuffing box dimensions and recommendations for speed limits are not considered here. Consideration of high – speed problems should be referred to INMARCO's customer service department.

INSTALLATION OF INMARCO PUMP PACKINGS

The importance of packing the pump correctly cannot be overemphasized. Many failures are due to incorrect installation of packings. The following steps have been devised to ensure effective installation of packing on pumps.

1. Remove all the old packing from the stuffing box. Clean box and shaft thoroughly and examine shaft or sleeve for wearing and scoring. Replace shaft or sleeve if wear is excessive.
2. Use the correct cross-section of packing or die-formed rings. To determine the correct packing size, measure the diameter of the shaft (inside the stuffing box area if possible) and then measure the diameter of the stuffing box (to give the OD of the ring). Subtract the ID measurement from the OD measurement and divide by two. The result is required size (w).
3. When using coil or spiral packing, always cut the packing into separate rings. Never wind a coil of packing into a stuffing box. Rings can be with butt (square), skive (or diagonal) joints, depending on the method used for cutting. The following illustration shows these methods of preparing bulk packing. The best way is to cut them on a mandrel of same diameter as that of a shaft. If there is no shaft wear, rings can be cut on the shaft outside the stuffing box. Hold the packing tightly on the mandrel, but do not stretch. Cut the ring and insert it into the stuffing box, making sure if it fits the packing space properly. Each additional ring can be cut in the same manner. When cutting diagonal joints, use a meter board so that each successive ring can be cut at the correct angle. It is necessary that the rings be cut to the correct size. Otherwise, service life is reduced. This is where die-cut rings are advantage, as they give the exact size.

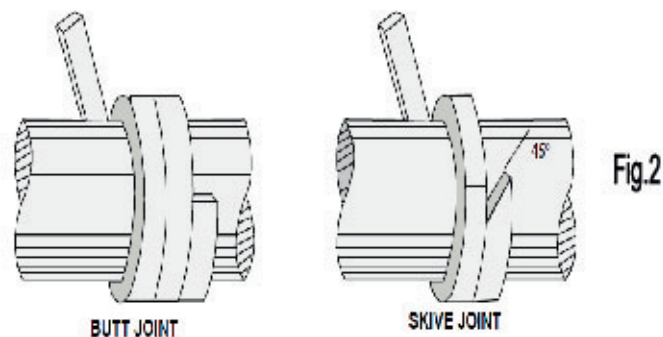





















Fig.2

4. Install one ring at a time: make sure it is clean and has not picked up any dirt in handling. Seat rings firmly (except PTFE filament and graphite yarn packing, which should be snugged up very gently, then tightened gradually after the pump is operating). Joints of successive rings should be staggered and kept at least 90° apart. Each individual ring should be firmly seated with a tamping tool.

Product Type	Description & Operational Parameters																																			
 <p data-bbox="256 972 312 992">INM065</p> <p data-bbox="108 1003 336 1034">INMARCO STYLE 300</p>	<p data-bbox="400 421 991 633">STYLE INGRAF® 300 is a high purity (99% to 99.9% carbon) self lubricating and anti-frictional die moulded pre-formed gland packing ring manufactured from Flexible Pure graphite Foil. These rings are manufactured in endless form or in 2 halves in oblique cut containing no Oil or grease or Binder/ Additives of any kind. The packing however is incorporated with sacrificial metal corrosion inhibitor to avoid Galvanic Corrosion on parent body.</p> <p data-bbox="400 667 991 902">STYLE INGRAF®300 is manufactured from flexible pure graphite tape vertically placed into the die and then pressed in hydraulic press and the pressure is calculated on the basis of required density. As the tapes are placed vertically & the compression also is vertical in a closed die there are chances of crimping of tape on OD & ID of the ring which are normally mistaken as cracks. These are not cracks but crimping of tape and this crimping provides resiliency in the sealing ring which is most important for perfect sealing against pressure surge.</p> <p data-bbox="400 936 991 1205">STYLE INGRAF®300 is totally free from any kind of contamination. For compression resistance and retention of size & shape Style 300 is manufactured with accurate specific density suitable to the working condition. These packing rings are having high thermal and dimensional stability and extremely low gas/liquid permeability, very low thermal expansion and extremely high chemical resistance. These rings are having low co-efficient of friction (0.08 to 0.1 against steel) and hence, with continuous operation it polishes the stem/shaft and also non abrasive in nature.</p> <p data-bbox="400 1238 991 1361">STYLE INGRAF® 300 Flexible pure graphite rings adjusts to any irregularities under moderate pressure and has resistance to pressure surge and thermal shock. These packing rings are chemically inert and also fire safe.</p>	<p data-bbox="1015 409 1519 622">STYLE INGRAF® 300 packing ring is having inherent characteristics of basic graphite and hence having high degree of flexibility, compatibility, conformity & resiliency. These rings expand radially to form perfect seal against the shaft and housing. Graphite is an extremely good thermal conductor & as such the packing dissipates heat away from the body leading to a longer life of the packing.</p> <p data-bbox="1015 656 1519 768">STYLE INGRAF® 300 is also manufactured for nuclear applications with slightly improved chemical properties. These packing's are stable even under exposure to high doses of nuclear radiation.</p> <table border="1" data-bbox="1015 779 1519 969"> <thead> <tr> <th>PROPERTIES</th> <th></th> <th></th> <th></th> </tr> </thead> <tbody> <tr> <td>pH</td> <td colspan="3">0-14</td> </tr> <tr> <td>TEMPERATURE (°C)</td> <td colspan="3">-200 to +600</td> </tr> <tr> <td>PRESSURE (BAR)</td> <td>150</td> <td>250</td> <td>300</td> </tr> <tr> <td>VELOCITY (m/s)</td> <td>—</td> <td>—</td> <td>—</td> </tr> <tr> <td>SIZE</td> <td>—</td> <td>—</td> <td>—</td> </tr> </tbody> </table> <p data-bbox="1015 992 1214 1014">Technical Specification:</p> <table border="1" data-bbox="1015 1025 1519 1193"> <tbody> <tr> <td>Carbon Content</td> <td>99% to 99.9%</td> </tr> <tr> <td>Ash Content</td> <td>2% (max.)</td> </tr> <tr> <td>Leachable Chloride</td> <td>35ppm to 50 ppm</td> </tr> <tr> <td>Density</td> <td>1.4 – 1.8 gms/cc</td> </tr> <tr> <td>Corrosion Inhibitor (zinc dust)</td> <td>4% (max.)</td> </tr> </tbody> </table> <p data-bbox="1015 1216 1150 1272">Typical Applications: Valves & Pumps.</p> <p data-bbox="1015 1294 1519 1373">Service Media: Superior heated and saturated steam, non oxidizing liquids and gases, fuel gases and hot blast.</p>	PROPERTIES				pH	0-14			TEMPERATURE (°C)	-200 to +600			PRESSURE (BAR)	150	250	300	VELOCITY (m/s)	—	—	—	SIZE	—	—	—	Carbon Content	99% to 99.9%	Ash Content	2% (max.)	Leachable Chloride	35ppm to 50 ppm	Density	1.4 – 1.8 gms/cc	Corrosion Inhibitor (zinc dust)	4% (max.)
PROPERTIES																																				
pH	0-14																																			
TEMPERATURE (°C)	-200 to +600																																			
PRESSURE (BAR)	150	250	300																																	
VELOCITY (m/s)	—	—	—																																	
SIZE	—	—	—																																	
Carbon Content	99% to 99.9%																																			
Ash Content	2% (max.)																																			
Leachable Chloride	35ppm to 50 ppm																																			
Density	1.4 – 1.8 gms/cc																																			
Corrosion Inhibitor (zinc dust)	4% (max.)																																			
 <p data-bbox="256 1821 312 1841">INM066</p> <p data-bbox="172 1852 280 1883">CARTSEAL</p>	<p data-bbox="400 1406 991 1485">CART SEAL is a carefully & sequentially designed set of assorted sealing ring set, keeping in mind the application parameters and the media to be installed in.</p> <p data-bbox="400 1529 991 1608">CART SEAL is a concept and not a single product. The set consist of top and bottom molded rings and intermediate braided rings as per the requirement.</p> <p data-bbox="400 1653 991 1765">CART SEAL is a combination of various sealing aids which enables optimum sealing by maintaining lower levels of friction, high degree of heat dissipation and excellent blocking of body or shaft leakage which may not be possible with a single fiber or a hybrid packing.</p> <p data-bbox="400 1798 991 1854">CART SEAL is able to replace mechanical seal in any kind of application reducing cost of sealing drastically.</p> <p data-bbox="400 1877 831 2000">Advantages: *Performance beyond set standards for volatile organic compound & hazardous chemicals. *Friction reduces by 15% to 25% than flat rings. *Self-adjustments to thermal & pressure cycling.</p> <p data-bbox="400 2033 959 2089">*Conforms API 589 & 607 also API 622 standards with ISO 15848 Certification for Fugitive Emission Control Norms</p>	<table border="1" data-bbox="1015 1406 1519 1608"> <thead> <tr> <th>PROPERTIES</th> <th></th> <th></th> <th></th> </tr> </thead> <tbody> <tr> <td>pH</td> <td colspan="3">0-14</td> </tr> <tr> <td>TEMPERATURE (°C)</td> <td colspan="3">-240 to +650</td> </tr> <tr> <td>PRESSURE (BAR)</td> <td>200</td> <td>500</td> <td>500</td> </tr> <tr> <td>VELOCITY (m/s)</td> <td>25</td> <td>30</td> <td>—</td> </tr> <tr> <td>SIZE</td> <td colspan="3">OD x ID x Total Length of Stuffing Box is to be mentioned.</td> </tr> </tbody> </table> <p data-bbox="1015 1641 1310 1697">Typical Application: Pumps, Valves, Reactors, Mixers, Agitators etc.</p> <p data-bbox="1015 1742 1519 1933">Service Media: Acids, Alkalis, Solvent, Amide, Aldehyde, Alcohol, Detergents, Pigments, Dyestuffs, paints, Emulsions, Synthetic molten materials, Fine chemicals, slurry, Liquid ammonia & Ammonium compounds, Carbamate solutions, Fuel & Lube oil, hydrazine, Emulsions, Tri sodium phosphate, Sodium Hexamate phosphate, Black & Green liquor, Paper pulp, Pulp diluted with water, Emulsion water and any other fluid media.</p>	PROPERTIES				pH	0-14			TEMPERATURE (°C)	-240 to +650			PRESSURE (BAR)	200	500	500	VELOCITY (m/s)	25	30	—	SIZE	OD x ID x Total Length of Stuffing Box is to be mentioned.												
PROPERTIES																																				
pH	0-14																																			
TEMPERATURE (°C)	-240 to +650																																			
PRESSURE (BAR)	200	500	500																																	
VELOCITY (m/s)	25	30	—																																	
SIZE	OD x ID x Total Length of Stuffing Box is to be mentioned.																																			

Product Type

Description & Operational Parameters



INM067

INMARCO STYLE 310

STYLE 310 INMARCO FLEXIBLE PURE GRAPHITE SELF SEALING RING/PRESSURE SEALING GASKET is made from flexible pure graphite foil, die moulded to required cross sectional profile reinforced with SS wire net/SS strip. The reinforcement of SS wire net/SS strip increases the mechanical strength of the ring/gasket which leads to extremely high pressure surge resistance.

STYLE 310 INMARCO FLEXIBLE PURE GRAPHITE SELF SEALING RING/PRESSURE SEALING GASKET is manufactured from corrugated flexible pure graphite tape vertically placed into the die and then pressed in hydraulic press and the pressure is calculated on the basis of required density. As the tapes are placed vertically and the compressions also are vertical in a closed die there are chances of crimping of tapes on OD & ID of the ring which are normally mistaken as cracks. These are not cracks but crimping provides resiliency in the sealing ring which is most important for perfect sealing against pressure surge.

STYLE 310 INMARCO FLEXIBLE PURE GRAPHITE SELF SEALING RING/PRESSURE SEALING GASKET is having carbon content 99.5% to 99.9%. These are manufactured in angular TOA cross sectional profile, square or rectangular cross sectional profile and BHEL ("V" on angle) cross sectional profile with high density. These are dimensionally stable under extreme pressure surge, highly thermal conductive and thermally stable. It is a better substitute of soft iron pressure seal gasket because of very good compressibility and recovery factor.

STYLE 310 INMARCO FLEXIBLE PURE GRAPHITE SELF SEALING RING/PRESSURE SEALING GASKET is also highly resistant to chemicals and can work in the entire PH range.

Advantages:

- *This packing does not disintegrate on cutting.
- *HITHERM dispersion acts as a blocking agent.
- *This packing adapts to worn out surface and pitting with smooth running.
- *Dissipates heat without chemical hardening.
- *Extremely smooth removal during shutdown.

PROPERTIES	VALUES
Ph Range	0-14
Temperature (°C)	-200 to +600
Pressure (BAR)	300
Velocity (m/s)	---
Size	---

Technical Specification:

Carbon Content	99.5% to 99.9%
Ash Content	0.5% max.
Leachable Chloride Content	<50 ppm
Density	1.8 – 2 gsm/cc

Cross Sectional Profiles:

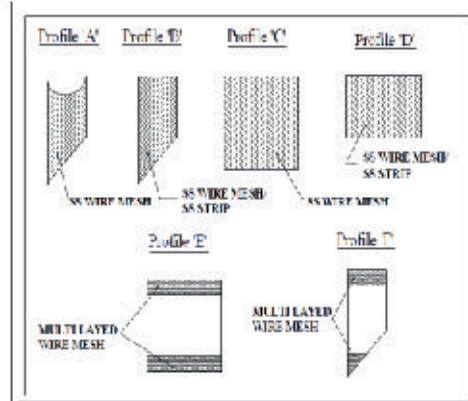

Service Media:

Super heated & Saturated steam, Hydrocarbon, Thermic fluid, Acids, Alkalis, Lube oil, etc.

Typical Application:

Valve bonnet, Metallic flanges, etc.

PROPERTIES	↻	↔	⚙
pH	0-14		
TEMPERATURE (°C)	-240 to +650		
PRESSURE (BAR)	350	350	---
VELOCITY (m/s)	25	25	---
SIZE	Customary sizes made to order		

Typical Application:

The variable densities of selected packing rings, adjust to wide range of chemicals including fluids, gases, VOC's or solids at variable temperature and pressure. The excellent sealability of valve cartseal enables total leak free performance over long runs. The costly on-line leak sealing can be eliminated.

Service Media:

Superheated & Saturated Steam, Hydrocarbon, Thermic Fluid, Acids and Alkalis, Solvent, Gases, Petrochemicals, etc.



INM068





















**EXPANDABLE VALVE
CARTSEAL**



















Fugitive emissions are hazardous and costly, as large process costs are involved in fluid or gas handling. VOC's find leak paths in valves along the stem. The steam leakages prove extremely costly on control of turbine valves, due to pressure and thermal fluctuations.

EVCS is a state of the art new generation seal designed specifically to conform to fugitive emission norms. V shape design permits effective sealing's at all times due to radial expansion of tips under live loadings. These seals have high performance capabilities and give excellent results in critical fluid and gas applications. These are custom built and manufactured to custom orders.

Advantages:































- *Performance beyond set standards for VOC, hazardous chemicals.
- *Friction reduces by 15-25%.
- *Slf adjustments to thermal and pressure cycles.

Product Type	Description	Operational Parameters																								
 <p>INM069 INMARCO STYLE 100FXI</p>	<p>STYLE 100FXI is manufactured from premium expanded graphite fibre yarn having minimum carbon content 98% reinforced with inconel wire. This is braided and thoroughly impregnated with proprietary Hitherm dispersion based on fine graphite and also incorporated with sacrificial metal corrosion inhibitor to prevent equipment from galvanic corrosion which leads to pitting on the stem & body.</p> <p>STYLE 100FXI the soft expanded graphite fibers are secured by strong but resilient inconel wire which ensures high pressure resistance. On demand the yarns can also be reinforced with multiple inconel wire to resist pressure surge.</p> <p>Advantages: *Self generating lubrication accommodates and aids self adjustment on tightening of the gland. *Hi-therm lubrication developed by us, in-house R & D prevents the body and shaft leakage on static or dynamic equipments.</p>	<table border="1"> <thead> <tr> <th>PROPERTIES</th> <th></th> <th></th> <th></th> </tr> </thead> <tbody> <tr> <td>pH</td> <td colspan="3">0-14</td> </tr> <tr> <td>TEMPERATURE (°C)</td> <td colspan="3">-240 to +650 in oxidizing media (3315°C in non oxidizing media)</td> </tr> <tr> <td>PRESSURE (BAR)</td> <td colspan="3">300</td> </tr> <tr> <td>VELOCITY (m/s)</td> <td colspan="3">---</td> </tr> <tr> <td>SIZE</td> <td colspan="3">3mm² to 90mm²</td> </tr> </tbody> </table> <p>Typical Application: Valves, Autoclaves, Rotary Kiln, etc.</p> <p>Service Media: Superheated and Saturated steam, Hydrocarbon, Thermic fluid, Petrochemical, Hot oil, etc.</p>	PROPERTIES				pH	0-14			TEMPERATURE (°C)	-240 to +650 in oxidizing media (3315°C in non oxidizing media)			PRESSURE (BAR)	300			VELOCITY (m/s)	---			SIZE	3mm ² to 90mm ²		
PROPERTIES																										
pH	0-14																									
TEMPERATURE (°C)	-240 to +650 in oxidizing media (3315°C in non oxidizing media)																									
PRESSURE (BAR)	300																									
VELOCITY (m/s)	---																									
SIZE	3mm ² to 90mm ²																									
 <p>INM070 INMARCO STYLE 800</p>	<p>STYLE 800 is a Premium Grade Expanded Graphite fibre yarn packing reinforced with Inconel/SS Wire having a core of bunch of carbonised filament. The packing is also impregnated with proprietary Hitherm dispersion based on fine Graphite and Sacrificial metal Corrosion Inhibitor.</p> <p>STYLE 800 is an improved Hi-Tech packing basically designed for Valves gland rating from 150 to 3000 class. This packing is also able to withstand extreme Pressure Surge and ensures a longer leakage free life.</p> <p>Advantages: *The Soft expanded graphited fibre is secured by strong but resilient inconel wire which ensures flexibility for wrapping around small diameter Shaft & Spindle. *The core of bunch of carbonised yarn increases the tensile strength to withstand high pressure at the same time high temperature. *Self generating lubrication accommodates and aids self adjustment on tightening of the gland. *Hi-therm lubrication developed by us, in-house R&D prevents the body and shaft leakage on static or dynamic equipment.</p>	<table border="1"> <thead> <tr> <th>PROPERTIES</th> <th>VALUES</th> </tr> </thead> <tbody> <tr> <td>pH</td> <td>0 - 14</td> </tr> <tr> <td>TEMPERATURE (°C)</td> <td>-240 TO 650 (1200°C in Non oxidizing media)</td> </tr> <tr> <td>PRESSURE (BAR)</td> <td>300</td> </tr> <tr> <td>VELOCITY (m/s)</td> <td>---</td> </tr> <tr> <td>SIZE</td> <td>6mm² to 50mm²</td> </tr> </tbody> </table> <p>Typical Application: Valves, Dryers, Autoclaves, etc.</p> <p>Service Media: Superheated & Saturated Steam, Hydrocarbon, gases, Ammonia, Hydrogen, Petrochemicals, etc.</p>	PROPERTIES	VALUES	pH	0 - 14	TEMPERATURE (°C)	-240 TO 650 (1200°C in Non oxidizing media)	PRESSURE (BAR)	300	VELOCITY (m/s)	---	SIZE	6mm ² to 50mm ²												
PROPERTIES	VALUES																									
pH	0 - 14																									
TEMPERATURE (°C)	-240 TO 650 (1200°C in Non oxidizing media)																									
PRESSURE (BAR)	300																									
VELOCITY (m/s)	---																									
SIZE	6mm ² to 50mm ²																									
 <p>INM071 INMARCO STYLE 100FX</p>	<p>STYLE 100FX Expanded flexible pure graphite fibre (purity 99% minimum) braided packing reinforced with non metallic filament. The packing is extrusion resistant and capable of withstanding higher pressure both in dynamic and static condition.</p> <p>STYLE 100FX packing is also impregnated with proprietary hitherm dispersion to fill the leak paths between the braids. Under gland pressure it becomes a homogeneous mass.</p> <p>Advantages: *Self generating lubrication accommodates and aids self adjustment on stem upon tightening of gland. *Most effective sealing performance & no scoring of sleeve, plunger or stem. *Hitherm lubrication developed by us, in-house R & D prevents the body and shaft leakage on static or dynamic equipment. *Suits for high mechanical & cylindrical load. *Excellent sealing during long duration.</p>	<table border="1"> <thead> <tr> <th>PROPERTIES</th> <th></th> <th></th> <th></th> </tr> </thead> <tbody> <tr> <td>pH</td> <td colspan="3">0-14</td> </tr> <tr> <td>TEMPERATURE (°C)</td> <td colspan="3">-200 to +650 (2700°C in non oxidizing media)</td> </tr> <tr> <td>PRESSURE (BAR)</td> <td>35</td> <td>80</td> <td>100</td> </tr> <tr> <td>VELOCITY (m/s)</td> <td>20</td> <td>10</td> <td>---</td> </tr> <tr> <td>SIZE</td> <td colspan="3">3mm² to 50mm²</td> </tr> </tbody> </table> <p>*not suitable for valves beyond class 300</p> <p>Typical Application: Pumps, Valves, Dryers, Reactors, etc.</p> <p>Service Media: Superheated & Saturated steam, Gases, Petrochemicals, Hydrocarbon, Thermic fluid, Hot oil, Acids & Alkalis, Solvents, Organic chemicals, Emissive fluids, etc.</p>	PROPERTIES				pH	0-14			TEMPERATURE (°C)	-200 to +650 (2700°C in non oxidizing media)			PRESSURE (BAR)	35	80	100	VELOCITY (m/s)	20	10	---	SIZE	3mm ² to 50mm ²		
PROPERTIES																										
pH	0-14																									
TEMPERATURE (°C)	-200 to +650 (2700°C in non oxidizing media)																									
PRESSURE (BAR)	35	80	100																							
VELOCITY (m/s)	20	10	---																							
SIZE	3mm ² to 50mm ²																									

Product Type	Description	Operational Parameters																					
 <p>INM072</p> <p>INMARCO STYLE 100FXI SPECIAL</p>	<p>STYLE 100FXI SPECIAL is a premium expanded pure graphite (carbon content 99.5 to 99.9%) fibre yarn braided packing, each yarn of which is reinforced with multiple inconel wire, thoroughly incorporated with inorganic passive corrosion inhibitor & special lubricating agents. This passive corrosion inhibitor safeguards parent equipment from galvanic corrosion and also reduction of loss on ignition. Each yarn is jacketed with inconel wire mesh. Reinforcement & jacketing with inconel wire mesh in each yarn enables the packing to withstand extreme mechanical stress and cyclic loads.</p> <p>Advantages:</p> <ul style="list-style-type: none"> *Excellent sealing under mechanical & thermal stress or cyclic loads. *Low wear and tear means long sealing life. *Emission much below the EPI limits. *Highly resistant to pressure and extrusion. <p>Approved Fire safe under clause Api 589/607 and Confirms to Fugitive Emission Norms as per API 622</p>	<table border="1"> <thead> <tr> <th>PROPERTIES</th> <th></th> <th></th> <th></th> </tr> </thead> <tbody> <tr> <td>pH</td> <td></td> <td></td> <td>0-14</td> </tr> <tr> <td>TEMPERATURE (°C)</td> <td></td> <td></td> <td>-240 to +650</td> </tr> <tr> <td>PRESSURE (BAR)</td> <td></td> <td></td> <td>500</td> </tr> <tr> <td>SIZE</td> <td></td> <td></td> <td>3mm² to 50mm²</td> </tr> </tbody> </table> <p>Typical Application: Valves, Screw conveyers, Dryers, etc.</p> <p>Service Media: All non oxidising liquids & gases, Super heated & Saturated steam, Hot dry ash, Flue gases, Dyes & Chemicals, Emissive fluids, Fuel Oil & Lube oil, Thermic fluid, Hydrocarbons, etc.</p> <p>Benefits:</p> <ul style="list-style-type: none"> *A special lubricating agent reduces stem friction & corrosion inhibitor prevents pitting due to galvanic corrosion. * Very high sealing efficiency even on oscillating valve stems without much wear and tear. *The reinforcement & jacketing of inconel wire enhances the strength of packing & withstand high temperature & pressure. 	PROPERTIES				pH			0-14	TEMPERATURE (°C)			-240 to +650	PRESSURE (BAR)			500	SIZE			3mm ² to 50mm ²	
PROPERTIES																							
pH			0-14																				
TEMPERATURE (°C)			-240 to +650																				
PRESSURE (BAR)			500																				
SIZE			3mm ² to 50mm ²																				
 <p>INM073</p> <p>INMARCO STYLE 900</p>	<p>STYLE 900 is a premium flexible expanded graphite fiber packing with high carbon content impregnated with proprietary thermolube® dispersion reinforced with Inconel wire/SS wire in each strand. The packing also incorporates of inorganic passive corrosion inhibitor to safeguard parent body from galvanic corrosion and reduce loss on ignition.</p> <p>STYLE 900 is a soft expanded graphite Fiber packing secured by strong but resilient Inconel wires/ SS wires which ensures flexibility for wrapping around small diameter shaft and spindle. Moreover, reinforcement of Inconel wire of special grade enhances the mechanical strength of the packing which increases the resistance to pressure surge.</p> <p>Advantages:</p> <ul style="list-style-type: none"> *The thermolube® dispersion acts as a blocking agent and fill up the hair gap between the yarns to ensure zero leakage. *Self-generating lubrication accommodates and aids self-adjustment on tightening of the gland. *There is no volume loss due to loss on ignition. 	<table border="1"> <thead> <tr> <th>PROPERTIES</th> <th>VALUES</th> </tr> </thead> <tbody> <tr> <td>pH</td> <td>0-14</td> </tr> <tr> <td>TEMPERATURE (°C)</td> <td>-200 to +650</td> </tr> <tr> <td>PRESSURE (BAR)</td> <td>500</td> </tr> <tr> <td>VELOCITY (m/s)</td> <td>---</td> </tr> <tr> <td>SIZE</td> <td>3mm² to 50mm²</td> </tr> </tbody> </table> <p>Typical Application: Valves, Dryers, Rotary Kiln, etc.</p> <p>Service Media: Superheated & Saturated Steam, Hydrocarbon, Thermic Fluid, Acids and Alkalis, Solvent, Gases, Petrochemicals, etc.</p>	PROPERTIES	VALUES	pH	0-14	TEMPERATURE (°C)	-200 to +650	PRESSURE (BAR)	500	VELOCITY (m/s)	---	SIZE	3mm ² to 50mm ²									
PROPERTIES	VALUES																						
pH	0-14																						
TEMPERATURE (°C)	-200 to +650																						
PRESSURE (BAR)	500																						
VELOCITY (m/s)	---																						
SIZE	3mm ² to 50mm ²																						
 <p>INM074</p> <p>INMARCO STYLE 1300/1310</p>	<p>JOINT SEALANT/VALVE STEM PACKING</p> <p>Joint Sealant (flat) & valve Stem Packing (round) are made from 100% pure expanded PTFE designed to be used as gap filling dependable sealants for flanges & valve glands. Flexible & heat stabilized Inmatex sealant eliminates the disadvantages associated with embrittlement & heat retention of gasket and made from conventional PTFE. Inmatex is a reliable seal due to its inertness to most chemicals and is also cost effective alternative on most flanges and valve glands.</p> <p>Construction: Flat tapes for flange joints, with or without adhesive backing. Round cords for valve stems.</p> <p>Advantages:</p> <ul style="list-style-type: none"> *Due to its excellent resilience property, Inmatex could withstand high compressive loads. *Resistant to creep, hot & cold flow. *Safe & clean for food & pharmaceutical applications. *Fast assembly, easy compression. 	<table border="1"> <thead> <tr> <th>PROPERTIES</th> <th></th> <th></th> </tr> </thead> <tbody> <tr> <td>pH</td> <td></td> <td>0-14</td> </tr> <tr> <td>TEMPERATURE (°C)</td> <td></td> <td>-260 to +300</td> </tr> <tr> <td>PRESSURE (BAR)</td> <td>100</td> <td>Vacuum to 200</td> </tr> <tr> <td>P x T</td> <td colspan="2">2 x 10⁶</td> </tr> <tr> <td>Sizes for Joint Sealants (width x thickness in mm)</td> <td colspan="2">3 x 1.5, 5 x 2, 7 x 2.5, 10 x 3, 12 x 4, 14 x 5, 17 x 6, 20 x 7 & 25 x 10</td> </tr> <tr> <td>Sizes for Valve Stem Packing (width x thickness in mm)</td> <td colspan="2">2, 2.5, 3, 4, 6, 8, 10, 12, 13, 16, 17, 19 & 20</td> </tr> </tbody> </table> <p>Typical Application: Ideal for fragile glass, FRP, Ceramic, Plastic flanges & Lined pipe joints. Flanges involving all kinds of chemical fluids & gaseous mediums. Graphite flanges in HCL, PVC & Nuclear plants.</p>	PROPERTIES			pH		0-14	TEMPERATURE (°C)		-260 to +300	PRESSURE (BAR)	100	Vacuum to 200	P x T	2 x 10 ⁶		Sizes for Joint Sealants (width x thickness in mm)	3 x 1.5, 5 x 2, 7 x 2.5, 10 x 3, 12 x 4, 14 x 5, 17 x 6, 20 x 7 & 25 x 10		Sizes for Valve Stem Packing (width x thickness in mm)	2, 2.5, 3, 4, 6, 8, 10, 12, 13, 16, 17, 19 & 20	
PROPERTIES																							
pH		0-14																					
TEMPERATURE (°C)		-260 to +300																					
PRESSURE (BAR)	100	Vacuum to 200																					
P x T	2 x 10 ⁶																						
Sizes for Joint Sealants (width x thickness in mm)	3 x 1.5, 5 x 2, 7 x 2.5, 10 x 3, 12 x 4, 14 x 5, 17 x 6, 20 x 7 & 25 x 10																						
Sizes for Valve Stem Packing (width x thickness in mm)	2, 2.5, 3, 4, 6, 8, 10, 12, 13, 16, 17, 19 & 20																						

COMPRESSION PACKINGS

VALVE SEALING

Product Type	Description	Operational Parameters																								
 <p>INM075 INGRAF BF</p>	<p>INGRAF® Box Foil Gasket Tape is made from 100% pure flexible graphite with knurled surface. Simply wind around valve stem and top up..</p> <p>Advantages:</p> <ul style="list-style-type: none"> *Could be used by itself or in combination with other packings for effective sealing and possible nuclear compatibility. *Wide range of pressure and thermal compatibility. *Low friction & permeability, eliminates wear and associated risks in equipment ensuring plant safety. *Emergency replacement packing for virtually any equipment. 	<table border="1"> <thead> <tr> <th>PROPERTIES</th> <th></th> <th></th> <th></th> </tr> </thead> <tbody> <tr> <td>pH</td> <td colspan="3">0-14</td> </tr> <tr> <td>TEMPERATURE (°C)</td> <td colspan="3">-200 to +300, -200 to +650 in steam</td> </tr> <tr> <td>PRESSURE (BAR)</td> <td colspan="3">Vacuum 28" hg to 250</td> </tr> <tr> <td>VELOCITY (m/s)</td> <td>30</td> <td>3</td> <td>---</td> </tr> <tr> <td>SIZE</td> <td colspan="3">1/4" x 25ft., 1/2" x 25ft., 3/4" x 50ft. & 1" x 50ft.</td> </tr> </tbody> </table> <p>Typical Application: Pumps and valve glands, Mixers, Agitators, Autoclaves handling variety of fluids & gases.</p>	PROPERTIES				pH	0-14			TEMPERATURE (°C)	-200 to +300, -200 to +650 in steam			PRESSURE (BAR)	Vacuum 28" hg to 250			VELOCITY (m/s)	30	3	---	SIZE	1/4" x 25ft., 1/2" x 25ft., 3/4" x 50ft. & 1" x 50ft.		
PROPERTIES																										
pH	0-14																									
TEMPERATURE (°C)	-200 to +300, -200 to +650 in steam																									
PRESSURE (BAR)	Vacuum 28" hg to 250																									
VELOCITY (m/s)	30	3	---																							
SIZE	1/4" x 25ft., 1/2" x 25ft., 3/4" x 50ft. & 1" x 50ft.																									
 <p>INM076 INGRAF FJ</p>	<p>INGRAF FJ Gasket Tape is made from 100% pure flexible graphite, specially corrugated to enable ease of installation over flanges with circular or with complex sealing area. The tape has a unique self adhesive backing for overhead or vertical flange surfaces. At high temperature, the adhesive would integrate itself with the graphite by carbonizing. This tape is also available without adhesive.</p> <p>Construction: Corrugated foil with or without adhesive backing. Chloride content: less than 50ppm. Ash content: max. 0.5%.</p> <p>Inggraf tapes are available in 2 basic versions: Inggraf FJ® generally used for Flange Joints and Inggraf BF used for Box Foil.</p> <p>Advantages:</p> <ul style="list-style-type: none"> *Can be used in tandem as a complete gasket with conventional gasket types such as PTFE, Spiral Wound, metallic etc. *Can be used to form gaskets from a small diameter as 1" to every large diameters. *Nuclear compatibility, radiation resistance – 1.5 x 100 rads conforms to surface irregularities. *Non sticking while dismantling. 	<table border="1"> <thead> <tr> <th>PROPERTIES</th> <th></th> <th></th> <th></th> </tr> </thead> <tbody> <tr> <td>pH</td> <td colspan="3">0-14</td> </tr> <tr> <td>TEMPERATURE (°C)</td> <td colspan="3">-200 to +450</td> </tr> <tr> <td>PRESSURE (BAR)</td> <td colspan="3">Vacuum 28" hg to 300</td> </tr> <tr> <td>VELOCITY (m/s)</td> <td>---</td> <td>---</td> <td>---</td> </tr> <tr> <td>SIZE</td> <td colspan="3">1/4" x 25ft., 1/2" x 25ft., 3/4" x 50ft. & 1" x 50ft.</td> </tr> </tbody> </table> <p>Typical Application: Heat Exchangers, Reactors, Pumps, Valves, bonnets and for various service conditions. As a filler to spiral wound and metallic gaskets. Flanges made from fragile material like glass. To encapsulate & enhance the sealing efficiency of other gasketing materials, such as PTFE & other gasketing materials.</p>	PROPERTIES				pH	0-14			TEMPERATURE (°C)	-200 to +450			PRESSURE (BAR)	Vacuum 28" hg to 300			VELOCITY (m/s)	---	---	---	SIZE	1/4" x 25ft., 1/2" x 25ft., 3/4" x 50ft. & 1" x 50ft.		
PROPERTIES																										
pH	0-14																									
TEMPERATURE (°C)	-200 to +450																									
PRESSURE (BAR)	Vacuum 28" hg to 300																									
VELOCITY (m/s)	---	---	---																							
SIZE	1/4" x 25ft., 1/2" x 25ft., 3/4" x 50ft. & 1" x 50ft.																									
 <p>INM077 INMARCO STYLE 114V</p>	<p>STYLE 114V is a pure PTFE fibre yarn duplex braided packing manufactured from extruded trim tape having incorporation of special proprietary INLUBE break-in-lubricant. The break-in-lubricant ensures extra lubrication during the complete operational life.</p> <p>STYLE 114V is non toxic and inert in nature, hence ensures safety and purity of the fluid media. It is dimensionally stable and ensures trouble free operation reducing maintenance cost. STYLE 114V is suitable for dynamic as well as static application. As it is dimensionally stable it ensures leakage free operational life for a longer period.</p> <p>Typical Application: Valves, Mixers, Reactors, Agitators, Dryers, Air compressors, etc.</p>	<table border="1"> <thead> <tr> <th>PROPERTIES</th> <th></th> <th></th> <th></th> </tr> </thead> <tbody> <tr> <td>pH</td> <td colspan="3">0-14</td> </tr> <tr> <td>TEMPERATURE (°C)</td> <td colspan="3">-240 to +280</td> </tr> <tr> <td>PRESSURE (BAR)</td> <td>25</td> <td>100</td> <td>200</td> </tr> <tr> <td>VELOCITY (m/s)</td> <td>8</td> <td>4</td> <td>---</td> </tr> <tr> <td>SIZE</td> <td colspan="3">3mm² to 35mm²</td> </tr> </tbody> </table> <p>Service Media: Acids & Alkalis of any concentration, Solvents, Organic/Inorganic chemicals, Dyestuffs, Paints, Synthetic resins, etc.</p>	PROPERTIES				pH	0-14			TEMPERATURE (°C)	-240 to +280			PRESSURE (BAR)	25	100	200	VELOCITY (m/s)	8	4	---	SIZE	3mm ² to 35mm ²		
PROPERTIES																										
pH	0-14																									
TEMPERATURE (°C)	-240 to +280																									
PRESSURE (BAR)	25	100	200																							
VELOCITY (m/s)	8	4	---																							
SIZE	3mm ² to 35mm ²																									

CONTROL VALVE

 <p>INM078 INMARCO STYLE 503</p>	<p>STYLE 503 is a unique combination packing of expanded graphite yarn and carbon fibre yarn. This is one of the best solutions of sealing for all type of high pressure and high temperature valves specially in Control Valves. STYLE 503 is also extremely suitable for soot blower application. STYLE 503 is having a core consist of expanded graphite yarn reinforced with multiple inconnel wire further jacketed with fine inconnel wire mesh. The outer cover of the packing is braided with high strength-low friction-non scoring carbon yarn. STYLE 503 is finally incorporated with INORGANIC PASSIVE CORROSION INHIBITOR and graphite based proprietary HITHERM dispersion. This passive corrosion inhibitor safeguards parent equipment from galvanic corrosion and also reduction of LOSS ON IGNITION.</p> <p>Advantages:</p> <ul style="list-style-type: none"> *This packing does not disintegrate on cutting. *HITHERM dispersion acts as a blocking agent. *This packing adopts to worn out surface and pitting with smooth running. *Dissipates heat without chemical hardening. *Extremely smooth removal during shutdown. 	<table border="1"> <thead> <tr> <th>PROPERTIES</th> <th>VALUES</th> </tr> </thead> <tbody> <tr> <td>pH</td> <td>0-14</td> </tr> <tr> <td>TEMPERATURE (°C)</td> <td>-250 to +650</td> </tr> <tr> <td>PRESSURE (BAR)</td> <td>500</td> </tr> <tr> <td>VELOCITY</td> <td>---</td> </tr> <tr> <td>SIZE</td> <td>3mm² to 50mm²</td> </tr> </tbody> </table> <p>Typical Application: All types of Valves and Soot blowers, Specially Control Valve.</p> <p>Service Media: Hydrocarbon, Super heated & Saturated steam, Thermic fluid, Ammonia, Fuel oil, Lube oil, Non oxidizing liquids & gases, Amides, Dyes, Chemicals & Acids, Gasoline, etc.</p>	PROPERTIES	VALUES	pH	0-14	TEMPERATURE (°C)	-250 to +650	PRESSURE (BAR)	500	VELOCITY	---	SIZE	3mm ² to 50mm ²
PROPERTIES	VALUES													
pH	0-14													
TEMPERATURE (°C)	-250 to +650													
PRESSURE (BAR)	500													
VELOCITY	---													
SIZE	3mm ² to 50mm ²													



Innovations in Fluid Sealing.

INMARCO Fzc.

P. O. Box : 120284 SAIF Zone, Sharjah, U.A.E.
Tel : +971 6 557 8378 Fax : +971 6 557 8948
E-mail : info@inmarco.ae
www.inmarco.ae

INMARCO EMIRATES L.L.C.

P. O. Box : 91937, Mussafah, Abu Dhabi, U.A.E.
Tel : +971 2 552 1818 Fax : +971 2 552 1718
E-mail : abudhabi@inmarco.ae
www.inmarco.ae